

SafePass Warning Lights & Sounders

Rotech has access to a wide range of voice sounders, sirens and warning lights. Listed below are items that are available from stock, for any other requirements please contact us.

	<p>LP Series LP1 Xenon Strobe Beacon 2W low profile</p> <ul style="list-style-type: none"> • 2W xenon strobe beacons • Low profile design • Multi-voltage options 12 – 24vdc • Can be surface or wall mounted • IP67
	<p>SCA LED Warning Lamp (10-30v)</p> <ul style="list-style-type: none"> • 60 high bright LEDs • Multi voltage 12-30vdc • 75 FPM • IP 67 Poly Carbonate lens and base • Low power consumption
	<p>SIR-EJ and SIR-EJ LED Electronic Sounders and Strobe</p> <ul style="list-style-type: none"> • Multi-function electronic sounder or sounder with red LED beacon combination • 2 stage alarm on sounder version, output up to 105dB@1m • 3 stage alarm on sounder-beacon version (flashing, flashing with sound, steady with sound) • Tones include those meeting AS1670 and AS2220 • Surface mount with shallow or deep base • Available in red or white body • Multi-voltage 12-24v ac/dc • IP65
	<p>YO8 - YL8 Series Industrial Electronic Sounders</p> <ul style="list-style-type: none"> • Electronic sounder or sounder/beacon combination • 32 tones • 2 stage alarm • Sounder and beacon controlled independently • YO8 12-24vdc and YL8 with LED 24vdc • IP65
	<p>A105NAX - Appello X Speech and Tone Sounders</p> <ul style="list-style-type: none"> • Electronic voice and tone sounder • Records, stores and plays back user defined voice messages (4 x 30s messages) • High voice and music reproduction quality • Message creation via built in microphone or line-in audio input • 45 tones — 4 tone stage — Independent volume control for tone and message • For multiple installations it is necessary to record messages only once on a master unit • Optional LED beacon • IP66

Technical Specifications

LP Series LP1 Xenon Strobe Beacon 2W (LP4xMV/5 – 5W)

Voltage	10-100VDC 20-72VAC
Current	250-60mA
Flash rate	75fpm
Protection	IP67
Duty	Continuous
Temp rating (°C)	-25 to +50
Cable Entry	M20
Construction	Polycarbonate base and lens

* Specify colour: A = Amber, B = Blue, C = Clear, G = Green, R = Red

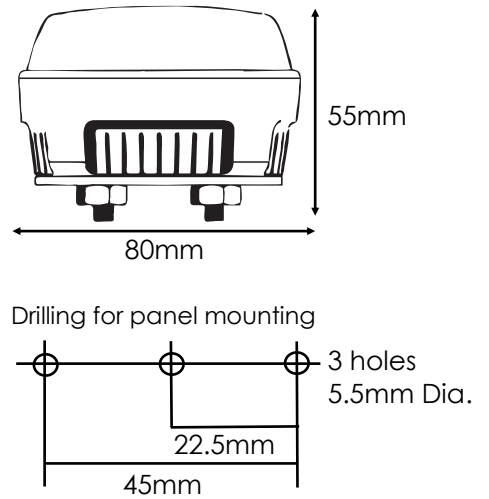

SCA LED Warning Lamp (10-30v)

Voltage	10-30VDC
Current	120 -190mA
Flash rate	75fpm
Protection	IP67
Duty	Continuous
Temp rating (°C)	-25 to +50
Cable Entry	M20
Construction	Polycarbonate base and lens

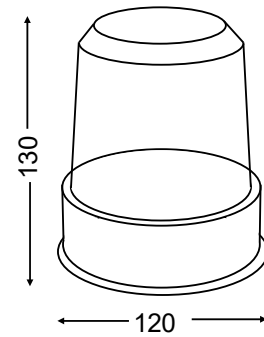

Dimensions in mm

SIR-EJ and SIR-EJ LED Electronic Sounders and Strobe

	Sounder Deep Base Red	Sounder/LED Deep Base Red/Red
Voltage	12-24VAC/DC	12-24VAC/DC
Current	215-250mA	300-350mA
Weight	0.26kg	0.37kg
Sound Output	105dB @ 1m	
Sound Frequency	SIR-EJ - 11 tones (2stages of 8 tones)	
Flash rate	3 x 85fpm ±10 or steady (Sounder-beacon version)	
Protection	IP65	
Duty	Continuous	
Temp rating (°C)	-30 to +50	
Cable Entry	M20 or through mounting base	
Construction	Polycarbonate	

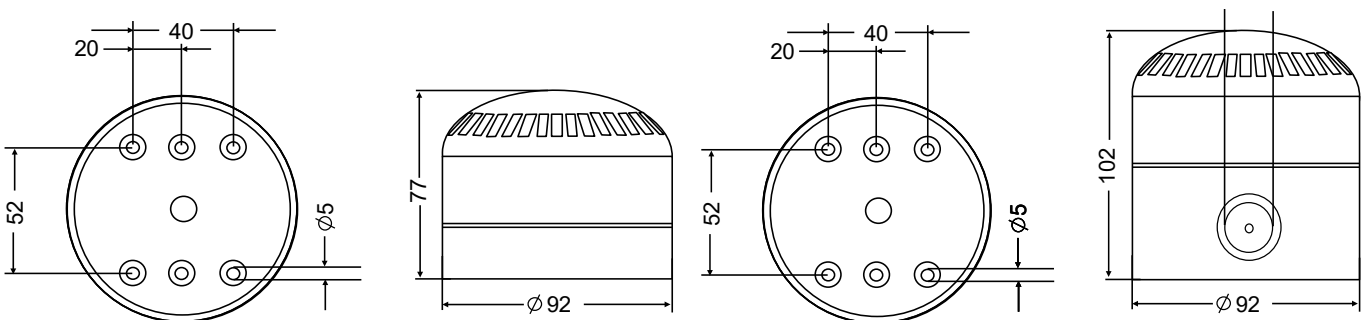

Dimensions in mm

YO8—YL8 Series Industrial Electronic Sounders

	YO8	YL8
Voltage	12–35VDC	24VDC
Current	300–330mA	600mA
Weight	2.5kg	3kg
Sound Output	Max 116dB @1m	
Sound Frequency	32 Tones	
Flash rate	60fpm	
Protection	IP65	
Duty	Continuous	
Temp rating (°C)	-25 to +55	
Cable Entry	2 x 20mm	
Construction	Flame retardant ABS	

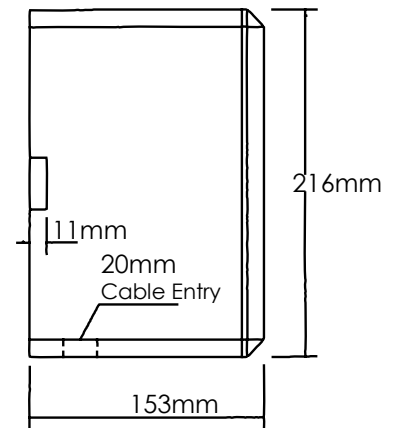
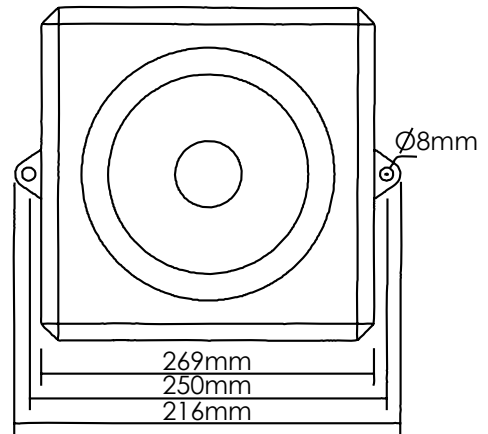

A105NAX - Appello X Speech and Tone Sounders

	A105NAX Appello X	AL105NAX Appello X with LED beacon*
Voltage	10–30VDC	10–30VDC
Current	256mA @ 230VAC	413mA @ 230VAC
Weight	1kg	1kg
Sound Output	Tone—Max 110dB @1m Voice—Max 101dB @ 1m	Tone—Max 126dB @1m Voice—Max 111dB @ 1m
Sound Frequency	45 Tones	
Flash rate	4 x 30 second messages	
Protection	IP66	
Duty	Continuous	
Temp rating (°C)	-25 to +55	
Cable Entry	2 x 20mm knockouts	
Construction	Flame retardant ABS	

* Specify colour: A = Amber, B = Blue, C = Clear, G = Green, R = Red

